

Diffrient smart[™]

Designed by Niels Diffrient.
Made by Humanscale.

Humanscale[®]

Featuring a unique linear design, the Diffrient Smart chair is ideal for any high design environment. Created with Humanscale's revolutionary Form-Sensing Mesh Technology, Diffrient Smart's tri-panel backrest fits like a perfectly tailored shirt to provide exceptional lumbar support. Using Humanscale's weight-sensitive, self-locking recline mechanism, Diffrient Smart automatically adjust to each sitter and provides perfect support to any posture. Diffrient Smart is also available in Diffrient Smart Plus with a wider seat and additional support.



The Diffrient Smart chair is ideal for Workstations, Conference Rooms, Reception Areas and Home Offices

Features

Available in two versions, the Diffrient Smart and Diffrient SmartPlus, both include the following features:

- Distinctive linear design that compliment any environment
- Innovative weight-sensitive, self-locking recline mechanism with 20 degrees of movement uses each sitter's body weight to perfectly adjust the tension and recline of the chair
- Automatically pivoting backrest with seven-degree back tilt offers perfect lumbar comfort in all positions
- Unique arm design attaches to the back frame to provide support during full range of recline
- Tri-Panel non-stretch Mesh Technology provides perfectly tailored comfort and lumbar support for any posture
- Modular design ensures easy maintenance and allows the user to update the chair's aesthetic
- Contoured seat cushions that closely follow the body's shape and finished with a waterfall edge to offer long-term comfort, reduce pressure points and provide weight distribution
- A variety of high-performance textiles and proprietary meshes complement the chair's form
- 15 year warranty

Diffrient Smart Chair

- Supports user height range of 5'0" – 6'4" and weight range of 100 lbs – 400 lbs
- Contoured seat cushions measure 19.25" wide and 2" thick
- 16.25" - 18.75" seat depth adjustment range
- Chair weight: 34 lbs with arms, 31 lbs without arms

Diffrient Smart Plus Chair

- Supports user height range of 5'0" – 6'4" and weight range of 100 lbs – 400 lbs
- Contoured seat cushions measure 22" wide and 3" thick
- 17" - 19" seat depth adjustment range
- Chair weight: 37 lbs with arms, 34 lbs without arms
(Note: only available with with 4D arms & aluminum base)



Specifications

Diffrient Smart with Standard Cylinder

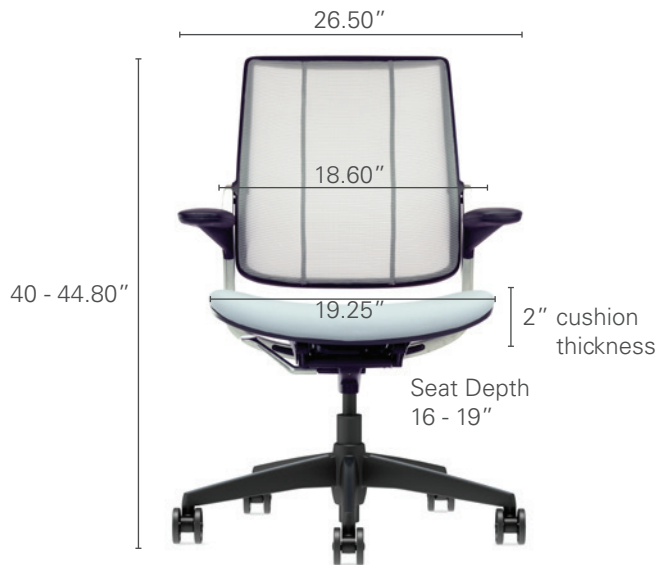

Diffrient Smart Plus with Standard Cylinder

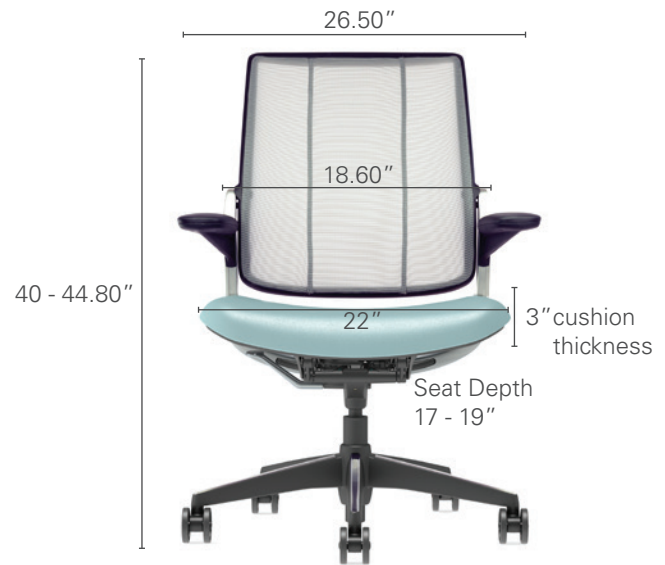

Available Options for Smart and Smart Plus

- **Textiles:** Range of four-way stretch fabrics, box-stitched leathers, antimicrobial textiles and non-stretch materials
- **Stitch Finishing:** Choice of matching or contrasting box stitching is available with all leather seat textile options
- **Backrest Meshes:** Available in a variety of breathable, uniquely flexible, yet supportive mesh options
- **Cushions:** Technogel cushions maximize weight distribution
- **Arms:**
 - Fixed arms in duron, with or without seat matching textile (standard Smart only)
 - Height-adjustable arms in duron, with or without seat matching textile (standard Smart Only)
 - 4D adjustable arms in duron, with or without seat matching textile (standard Smart and SmartPlus)
- **Finishes:** Black with black trim, gray with brushed aluminum trim or black with brushed aluminum trim
- **Cylinder:** Low, tall, high with footring and return to height
- **Casters:** Soft casters only
- **Bases:**
 - Plastic base (standard Smart only)
 - Aluminum base (standard Smart and Smart Plus)
- **CAL133**

Environmental Story

Like all Humanscale products, the Diffrient Smart chair was designed with a constant and genuine focus on its environmental impact at every stage of its development. For us, the best designs in the world achieve more with less, and sustainability is the natural result of this focus.

The Diffrient Smart chair's lightweight design minimizes the environmental impact of its shipping. Its use of highly recyclable aluminum and its simple, modular design makes it easy to disassemble and maintain rather than replace the chair completely. The Diffrient Smart chair is GREENGUARD Indoor Air Quality, GREENGUARD Gold and level® 2 certified.



“A smart chair adapts to your weight and shape automatically, as if the chair were made for you personally.”

Niels Diffrient